



**FERRODISMA**

**HERRAJES DE PUERTAS Y CANCELAS**



# HERRAJES DE PUERTAS Y CANCELAS

## ÍNDICE

### PUERTAS CORREDERAS

<i>RUEDAS SIN SOPORTE</i> .....	1
<i>RUEDAS PARA ATORNILLAR</i> .....	1
<i>RUEDAS PARA SOLDAR</i> .....	2
<i>RUEDAS PARA SOBREPONER</i> .....	2
<i>RODILLOS DE NYLON</i> .....	3
<i>CAJAS CON RODILLOS DE NYLON</i> .....	4
<i>TOPES FIN DE CARRERA</i> .....	4
<i>CARRILES - GUÍAS</i> .....	5
<i>CREMALLERAS</i> .....	5
<i>ROLDANAS</i> .....	6

### PUERTAS BASCULANTES

<i>POLEAS</i> .....	7
<i>BISAGRAS ÁNGULO SUPERIOR</i> .....	7
<i>ANTICAÍDAS</i> .....	7
<i>RODILLOS GUÍAS LATERALES</i> .....	8
<i>BISAGRAS DE LIBRILLO</i> .....	8
<i>MANETA PUERTA</i> .....	8

### CANCELAS

<i>SOPORTES DE GIRO CON RODAMIENTOS</i> .....	9
<i>PUNTOS DE GIRO CON BOLA</i> .....	9

Todas las medidas de este catálogo de muestras son aproximadas, la empresa se reserva el derecho de modificarlas sin previo aviso.

# HERRAJES DE PUERTAS Y CANCELAS



REF.	D (mm)	A (mm)	C (mm)	d (mm)	E	Acab.
PCU8020	78	25	28	20.5	M14x70	Zinc
PCU9020	88	25	30	20.5	M14x70	Zinc
PCU10020	98	25	30	20.5	M14x70	Zinc
PCU12020	118	25	34	20.5	M14x70	Zinc
PCU16020	158	30	45	20.5	M16x75	Zinc

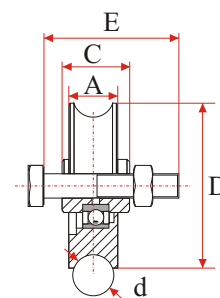

\* 2 RODAMIENTOS

REF.	D (mm)	A (mm)	C (mm)	d (mm)	E	Acab.
PCU20020	198	30	44	20.5	M16x75	Zinc

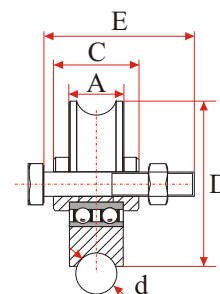

REF.	D (mm)	A (mm)	C (mm)	Canal	E	Acab.
PCV8020	78	20	28	V	M10x55	Zinc
PCV10020	98	22	30	V	M14x70	Zinc
PCV12020	118	25	34	V	M14x70	Zinc

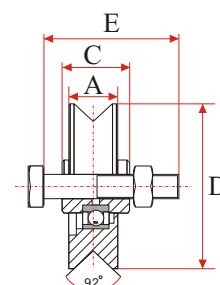

REF.	D (mm)	A (mm)	C (mm)	H (mm)	d (mm)	Acab.
PCUA8020	78	25	32	12	20.5	Zinc
PCUA9020	88	25	33	8	20.5	Zinc
PCUA10020	98	25	33	13	20.5	Zinc
PCUA12020	118	25	36	12	20.5	Zinc

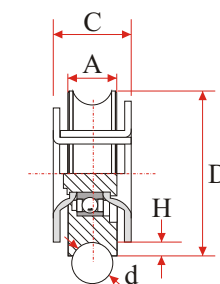

# HERRAJES DE PUERTAS Y CANCELAS

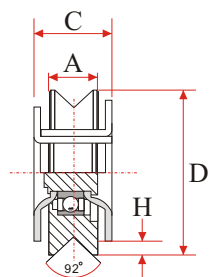

REF.	D (mm)	A (mm)	C (mm)	H (mm)	Acab.
PCVA8020	78	20	32	12	Zinc
PCVA9020	88	20	33	8	Zinc
PCVA10020	98	22	33	13	Zinc
PCVA12020	118	25	36	12	Zinc



HERRAJES

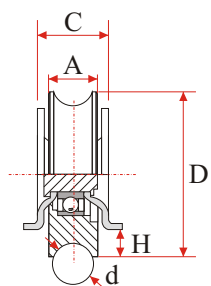

REF.	D (mm)	A (mm)	C (mm)	H (mm)	d (mm)	Acab.
PCUS8020	78	25	30	16	20.5	Zinc
PCUS9020	88	25	30	12	20.5	Zinc
PCUS10020	98	25	30	17	20.5	Zinc
PCUS12020	118	22	32	22	20.5	Zinc

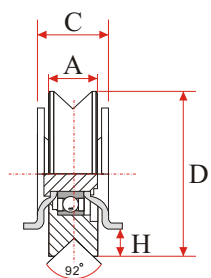

REF.	D (mm)	A (mm)	C (mm)	H (mm)	Acab.
PCVS8020	78	20	29	16	Zinc
PCVS9020	88	20	29	12	Zinc
PCVS10020	98	22	30	17	Zinc
PCVS12020	118	22	32	22	Zinc

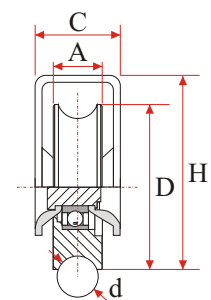

REF.	D (mm)	A (mm)	C (mm)	H (mm)	d (mm)	Acab.
PCUC8020	78	25	35	85	20.5	Zinc
PCUC9020	88	25	36	100	20.5	Zinc
PCUC10020	98	25	36	105	20.5	Zinc



# HERRAJES DE PUERTAS Y CANCELAS



\* 2 RODAMIENTOS

REF.	D (mm)	A (mm)	C (mm)	H (mm)	d (mm)	Acab.
PCUC12020	118	30	42	127	20.5	Zinc

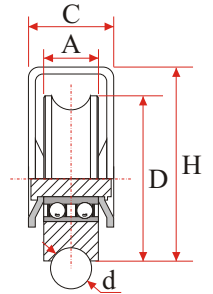

REF.	D (mm)	A (mm)	C (mm)	H (mm)	Acab.
PCVC8020	78	20	35	85	Zinc
PCVC9020	88	20	36	100	Zinc
PCVC10020	98	22	36	105	Zinc

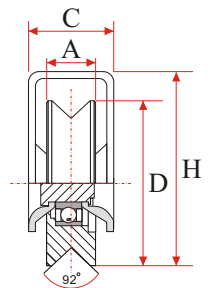

\* 2 RODAMIENTOS

REF.	D (mm)	A (mm)	C (mm)	H (mm)	Acab.
PCVC12020	118	30	42	127	Zinc

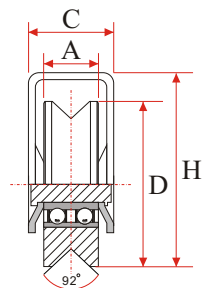

REF.	D (mm)	H1 (mm)	H (mm)	M
RN2540	25	40	75	12
RN3040	30	40	75	14
RN3540	40	44	90	16
RN4060	40	60	104	16

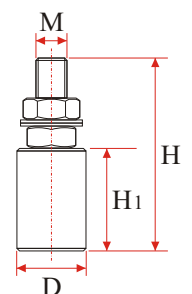

# HERRAJES DE PUERTAS Y CANCELAS

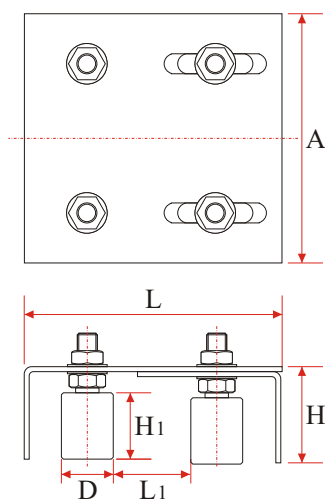

REF.	D (mm)	A (mm)	H1 (mm)	H (mm)	L (mm)	L1 (mm)
CP4RM	30	220	40	55	138-182	27-71
CP4RG	40	350	44	68	176-260	19-103

HERRAJES

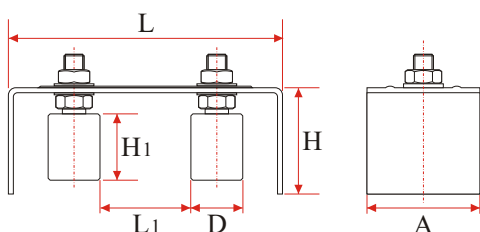

REF.	D (mm)	A (mm)	H1 (mm)	H (mm)	L (mm)	L1 (mm)
CP2RM	30	68	40	64	165	35-78
CP2RG	40	68	44	64	165	31-69

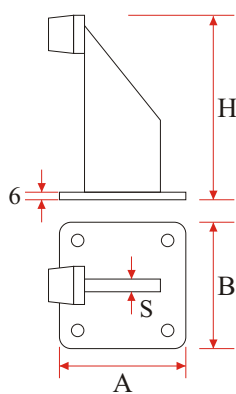

REF.	H (mm)	A (mm)	B (mm)	S (mm)	Acab.
TOA	146	100	100	10	Zinc

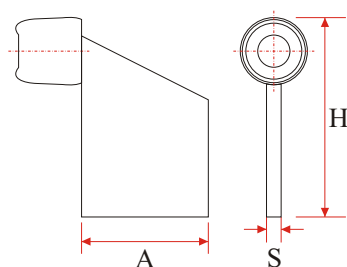

REF.	H (mm)	A (mm)	S (mm)	Acab.
TOS	95	50	8	Zinc

# HERRAJES DE PUERTAS Y CANCELAS



\*CANAL 20; LARGO 3M

REF.	L (mm)	H (mm)	S (mm)	Acab.
CAE3M	65	60	3.5	Zinc

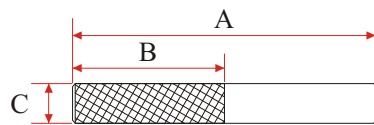
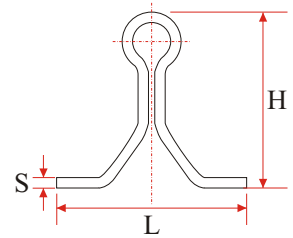

REF.	A (mm)	B (mm)	C (mm)	Acab.
UCA	100	50	13	Zinc

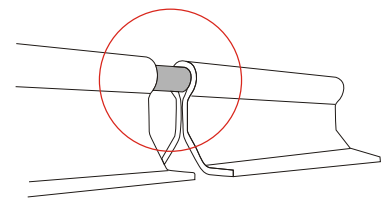

\*CANAL 20; LARGO 3M

REF.	L (mm)	H (mm)	S (mm)	A (mm)	B (mm)	Acab.
CAS3M	55	15	3.5	11	6	Zinc

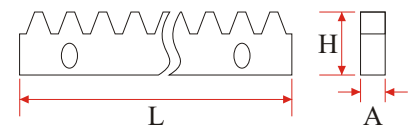
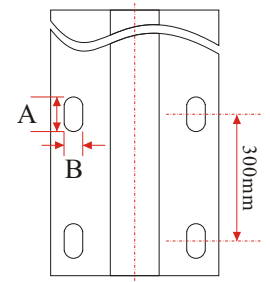
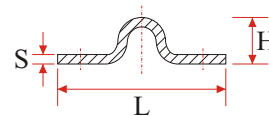

REF.	Módulo	A (mm)	H (mm)	L	Acab.
CRA2M	M.4	12	30	2M	Zinc

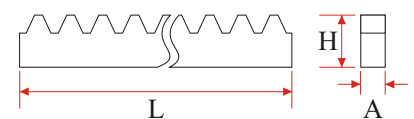

REF.	Módulo	A (mm)	H (mm)	L	Acab.
CRS2M	M.4	22	22	2M	Zinc

# HERRAJES DE PUERTAS Y CANCELAS

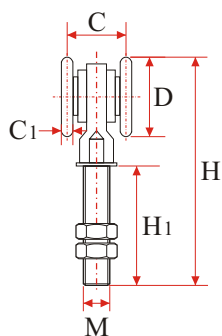

REF.	D (mm)	C (mm)	C1 (mm)	H (mm)	H1 (mm)	M	Acab.
<b>ROS40</b>	33.5	27	4	130	78	10	Zinc



HERRAJES

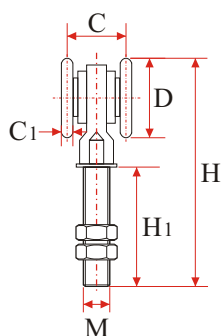

REF.	D (mm)	C (mm)	C1 (mm)	H (mm)	H1 (mm)	M	Acab.
<b>ROD40</b>	33.5	27	4	130	78	10	Zinc

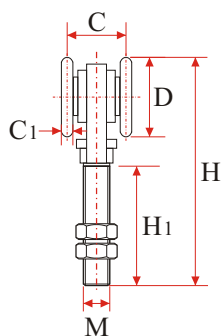

REF.	D (mm)	C (mm)	C1 (mm)	H (mm)	H1 (mm)	M	Acab.
<b>ROS60</b>	47	38	5	167	93	15	Zinc

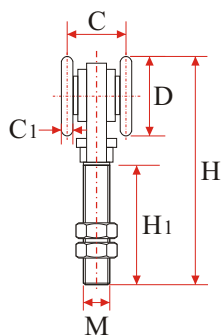

REF.	D (mm)	C (mm)	C1 (mm)	H (mm)	H1 (mm)	M	Acab.
<b>ROD60</b>	47	38	5	167	93	15	Zinc





# HERRAJES DE PUERTAS Y CANCELAS



REF.	D (mm)	A (mm)	M	d (mm)	Acab.
PC6010C	58	17	12	10	Zinc
PC7010C	68	17	16	10	Zinc
PC8010C	78	17	16	10	Zinc
PC9010C	88	17	16	10	Zinc
PC10010C	98	17	16	10	Zinc
PC12010C	118	17	16	10	Zinc

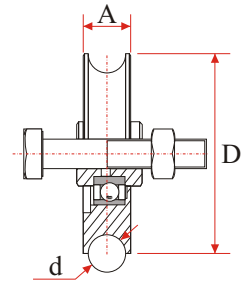

REF.	A (mm)	B (mm)	C (mm)	Acab.
BAS	40	40	26	Zinc

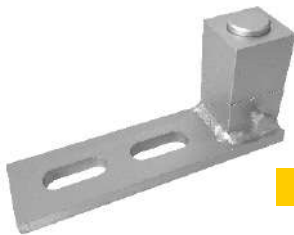
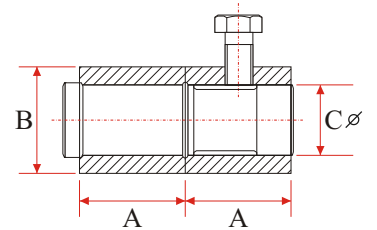

REF.	A (mm)	B (mm)	C (mm)	D (mm)	E (mm)	Acab.
BASCH-D	175	40	40	28	50	Zinc

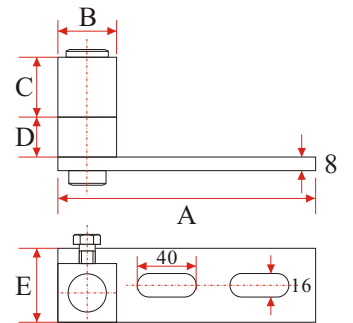

REF.	A (mm)	B (mm)	C (mm)	D (mm)	E (mm)	Acab.
BASCH-I	175	40	40	28	50	Zinc

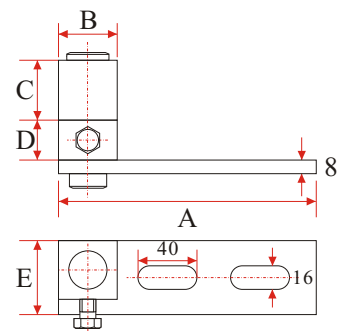

REF.	A (mm)	B (mm)	C (mm)	M	Utilidad	Acab.
ACU60	120	52	25	14	Perfil 60x3mm	Zinc
ACU80	157	70	31	16	Perfil 80x4mm	Zinc

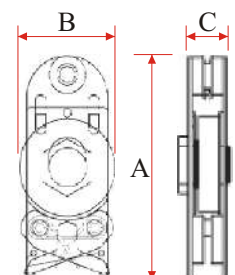

# HERRAJES DE PUERTAS Y CANCELAS

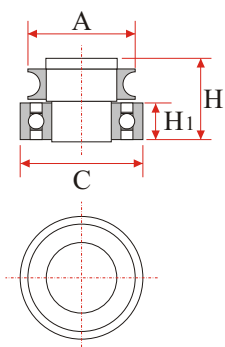

REF.	A (mm)	C (mm)	H (mm)	H1 (mm)	M	Utilidad	Acab.
ROU60	45	52	34	15	16	U-60	Zinc



HERRAJES

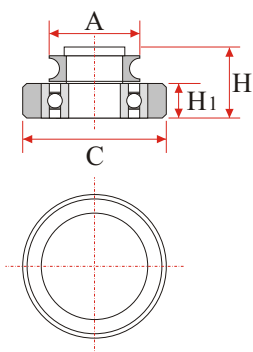

REF.	A (mm)	C (mm)	H (mm)	H1 (mm)	M	Utilidad	Acab.
ROU80	45	70.5	35	17	16	U-80	Zinc

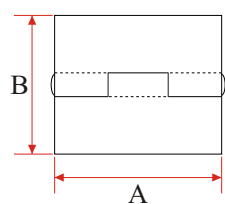

REF.	A (mm)	B (mm)	Acabado
BLS8050	80	50	Pulido
BLS10060	100	60	Pulido
BLS15060	150	60	Pulido

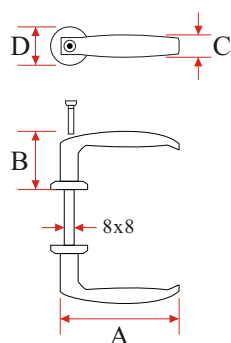

REF.	A (mm)	B (mm)	C (mm)	D (mm)	Acabado
MPBN	108	48	20	34	Lacado negro



# HERRAJES DE PUERTAS Y CANCELAS



REF.	D (mm)	H (mm)	Acab.
<b>BSG40</b>	40	34	Zinc
<b>BSG70</b>	70	36	Zinc

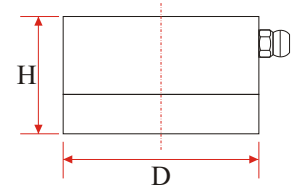

REF.	D (mm)	H (mm)	A (mm)	L (mm)	S (mm)	Acab.
<b>SGR40</b>	40	37	40	90	7	Zinc
<b>SGR70</b>	70	47	70	140	12	Zinc

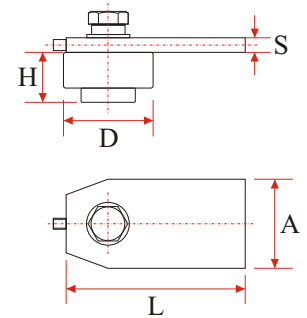

REF.	D (mm)	H (mm)	H1 (mm)	Acab.
<b>PGB40A</b>	40	53	30	Zinc

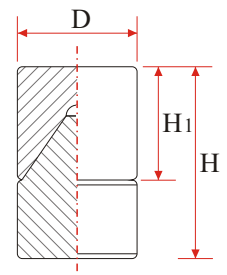

REF.	D (mm)	H (mm)	H1 (mm)	Acab.
<b>PGB40B</b>	40	60	50	Zinc

